

subject to technical alterations

type: M200
range: 300 - 430 mm *)
range of indication:
digital step:
scale interval: 0,050 mm
measuring force: 0,9 - 1,9 N
weight: 430 g

acceptable deviations
VDI/VDE/DGQ 2618 Bl. 12.1/13.1)
max. permissible errors "G": 0,150 mm
repeatability "r": 0,075 mm
reference temperature: 20° C
operation temperature: 10° C - 30° C
storage temperature: -10° C - 50° C

scale: 1 : 2
drawing-nr.: DAB-H4M300_KR_en
date of issue: 15.04.2013
name: Lange
revision status: 2096
revision date: 23.03.2015

measuring capacity

		measuring range Meb [mm]													
contact 1		300	302	304	306	308	310	315	320	325	330	335	340	345	350
contact 2		340	342	344	346	348	350	355	360	365	370	375	380	385	390
contact 3		380	382	384	386	388	390	395	400	405	410	415	420	425	430
groove depth A [mm]	0	0 / 163	0 / 164	0 / 165	0 / 166	0 / 167	0 / 168	0 / 172	0 / 183	0 / 192	0 / 192	0 / 192	0 / 192	0 / 192	0 / 192
	1		2,5 / 164	2,5 / 165	2,5 / 166	2,5 / 167	2,5 / 168	2,5 / 171	2,5 / 178	2,5 / 192	2,5 / 192	2,5 / 192	2,5 / 192	2,5 / 192	2,5 / 192
	2			2,6 / 164	2,6 / 165	2,6 / 166	2,6 / 167	2,6 / 170	2,6 / 176	2,6 / 192	2,6 / 192	2,6 / 192	2,6 / 192	2,6 / 192	2,7 / 192
	3				2,7 / 164	2,7 / 165	2,7 / 166	2,7 / 169	2,6 / 174	2,6 / 192	2,7 / 192	2,7 / 192	2,7 / 1,92	2,8 / 192	2,8 / 192
	4					2,8 / 165	2,8 / 166	2,7 / 168	2,7 / 172	2,7 / 192	2,7 / 192	2,8 / 192	2,9 / 192	2,9 / 192	3,0 / 192
	5						2,8 / 165	2,8 / 167	2,7 / 171	2,8 / 178	2,8 / 192	2,9 / 192	3,0 / 192	3,1 / 192	3,1 / 192
	B / L														

B = minimum groove width [mm]
L = maximum usable arm length [mm]

Example: Meb = 306 B = 2,6
A = 2 L = 165

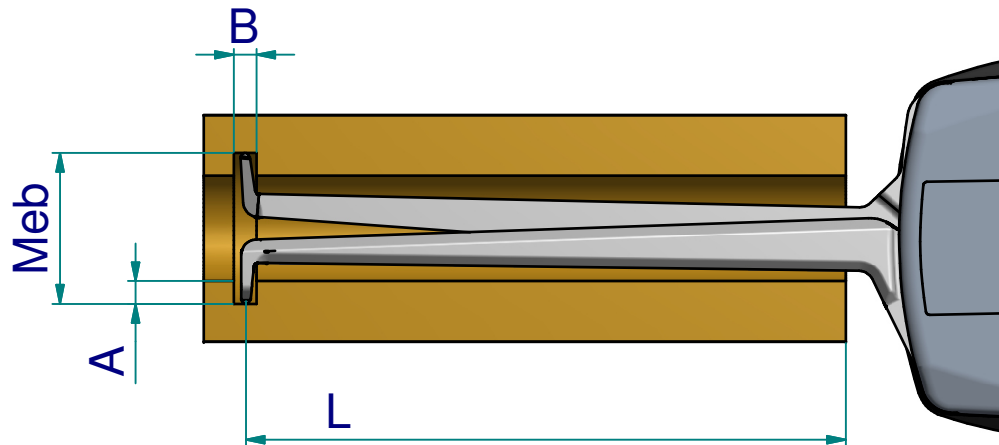

subject to technical alterations

drawing-nr.:	DAB-H4M300_KR_en
date of issue:	04.07.2013
name:	Lange
revision status:	2096
revision date:	23.03.2015